



## AFFORDABLE *elegance*

Customizable, versatile, color touch-screen room controller at an affordable price

Powered by  
**sedona**  
FRAMEWORK™

- 3.5" Renkli dokunmatik ekran
- İnce tasarım (10.5 mm)
- Serbestçe tasarlanabilir grafikler
- Çeşitli haberleşme seçenekleri
- Kablosuz iletişim seçeneği
- Doğrudan Belimo MP-Bus bağlantısı
- Serbestçe programlama



# R-ION

Sadece kullanıcı arabirimi olarak kullanma



24 Vdc/ac Besleme



RION-L0-S

RS485 Modbus

İzleme sistemi için

(Tüm modellerde üzerinde sıcaklık duyar elemanı mevcuttur)

# R-ION

İlave modbus (-L1 tipinde)

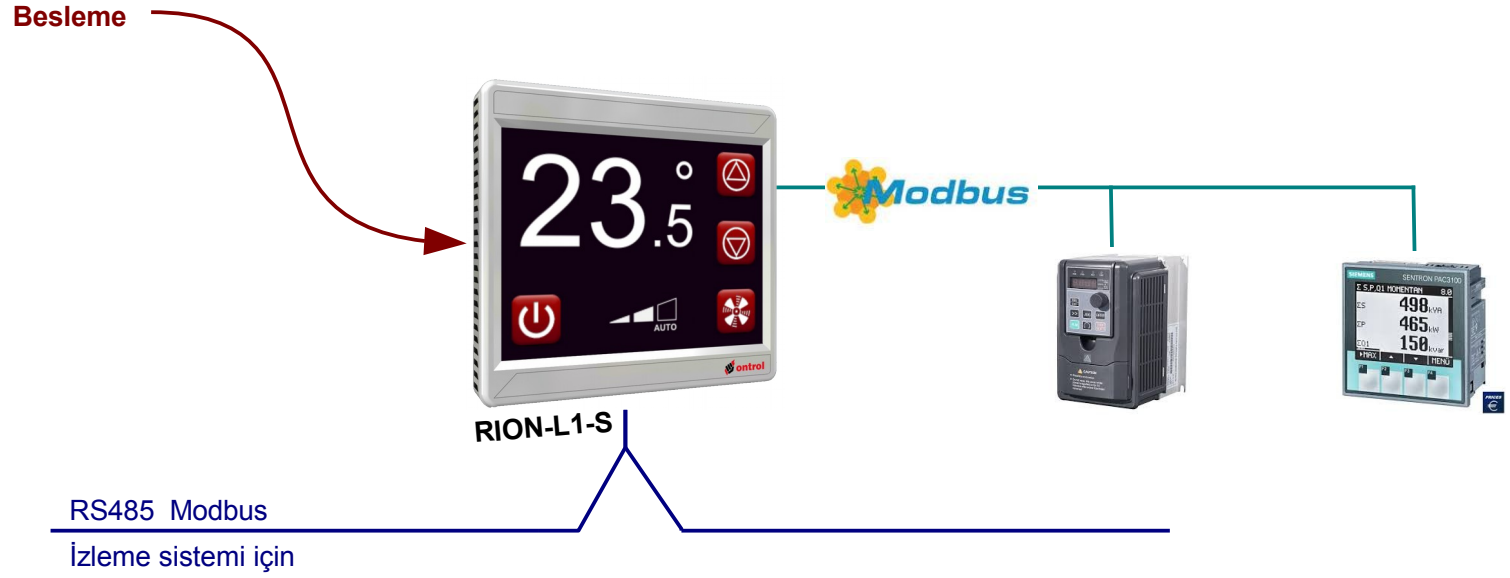

(Tüm modellerde üzerinde sıcaklık duyar elemanı mevcuttur)

# R-ION

Belimo MP-Bus ile basit VAV kontrolü



(Tüm modellerde üzerinde sıcaklık duyar elemanı mevcuttur)

# R-ION

## Dali ile basit aydınlatma kontrolü

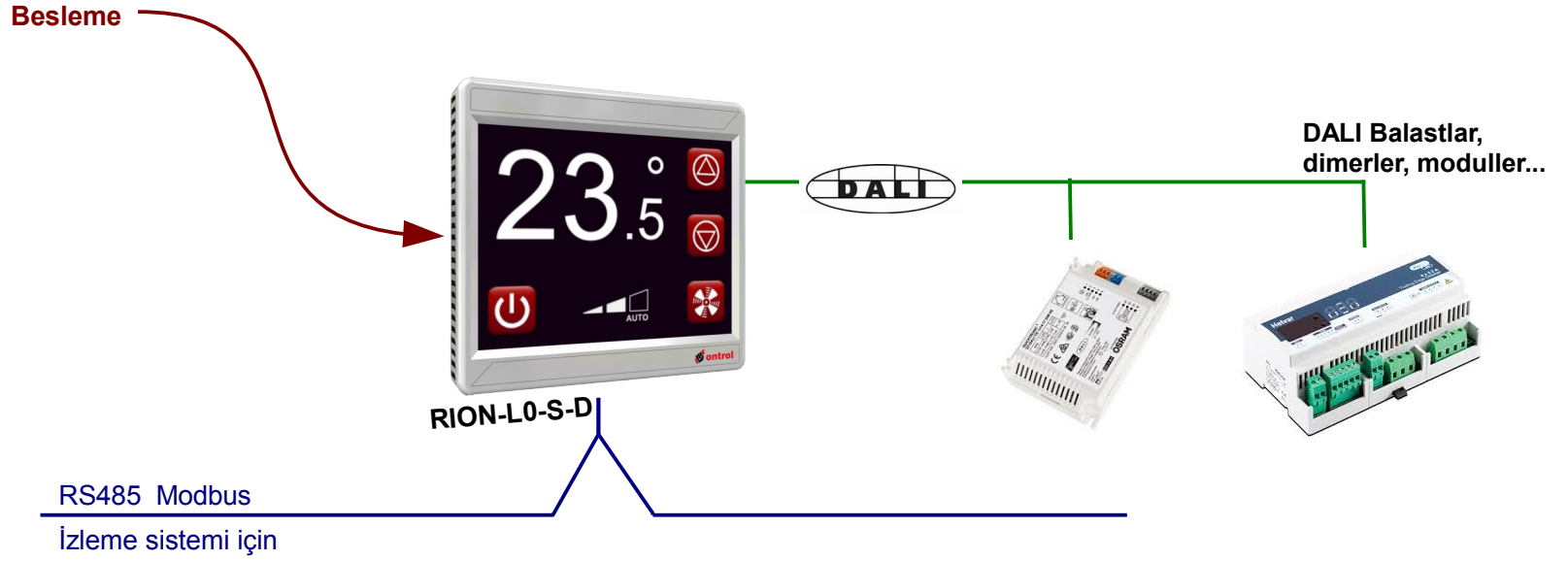

(Tüm modellerde üzerinde sıcaklık duyar elemanı mevcuttur)

# R-ION

Modbus + Mp-Bus + Dali



Evet, mümkün!

Besleme



RION-L1-S-BD

RS485 Modbus  
İzleme sistemi için

Modbus



MP-BUS



BELIMO  
VAV Devices

DALI

DALI Balastlar,  
dimerler, moduller...



(Tüm modellerde üzerinde sıcaklık duyar elemanı mevcuttur)

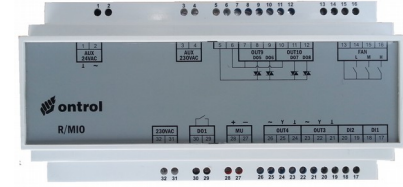
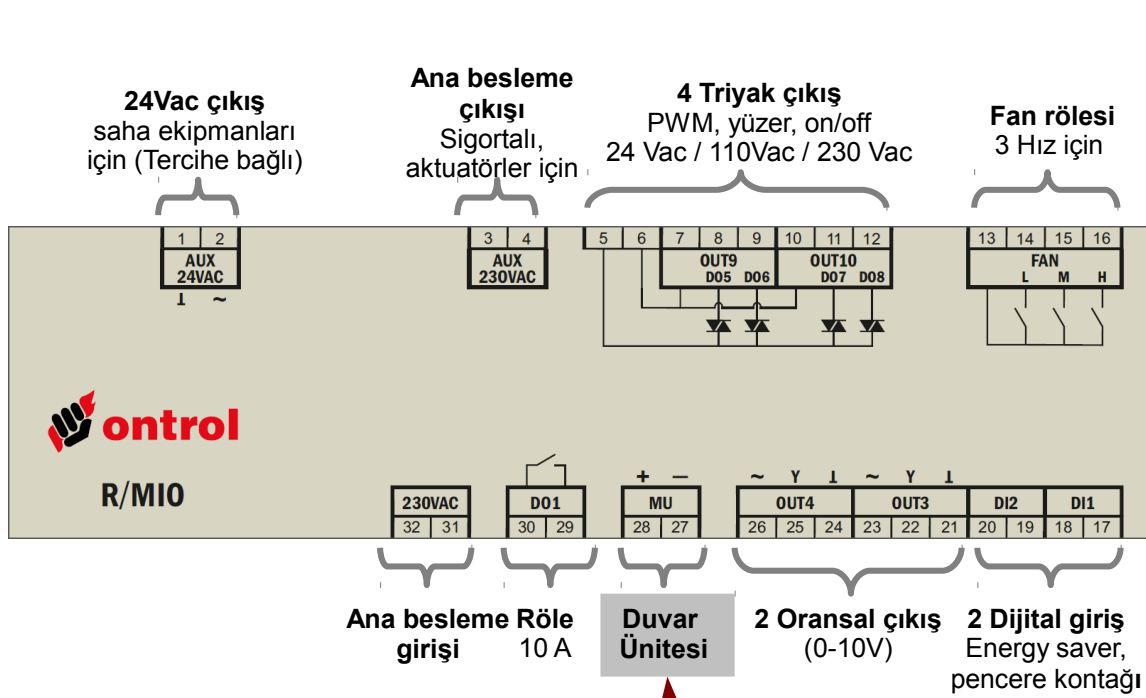

Ana besleme Röle girişi 10 A  
Duvar Ünitesi  
2 Oransal çıkış (0-10V)  
2 Dijital giriş Energy saver, pencere kontağı

Besleme ve haberleşme için sadece 2 damarlı kablo

### GİRİŞ / ÇIKIŞLAR

- 4 adet triyak çıkışı (Yüzer, PWM veya On/off kullanım için)
- 2 adet oransal (0-10V) çıkış
- 3 hızlı fan rölesi çıkışı
- 1 adet 10A röle çıkışı (Isıtıcı için)
- 2 adet dijital giriş (Kapı kontağı ve energy saver vs... için)



RS485 Modbus

İzleme sistemi için

(Tüm modellerde RION üzerinde sıcaklık duyar elemanı mevcuttur)



# R-ION

R/MIO + MpBus + DALI



Haberleşme seçenekleri  
halen geçerli!

(yardımcı modbus hariç)

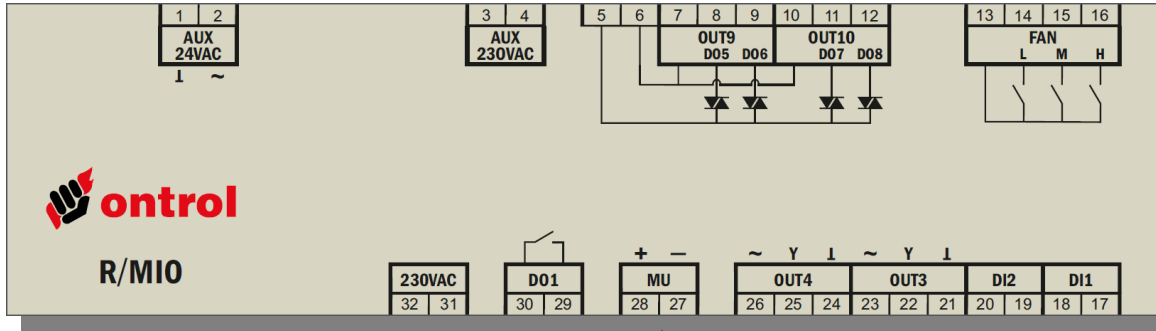

DALI Balastlar,  
dimerler, moduller...

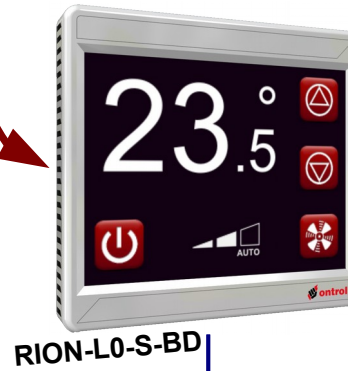

RS485 Modbus  
İzleme sistemi için

(Tüm modellerde RION üzerinde sıcaklık duyar elemanı mevcuttur)



MPBUS



BELIMO  
VAV Devices

# R-ION



WIFI seçeneği tüm seçeneklerde mevcuttur

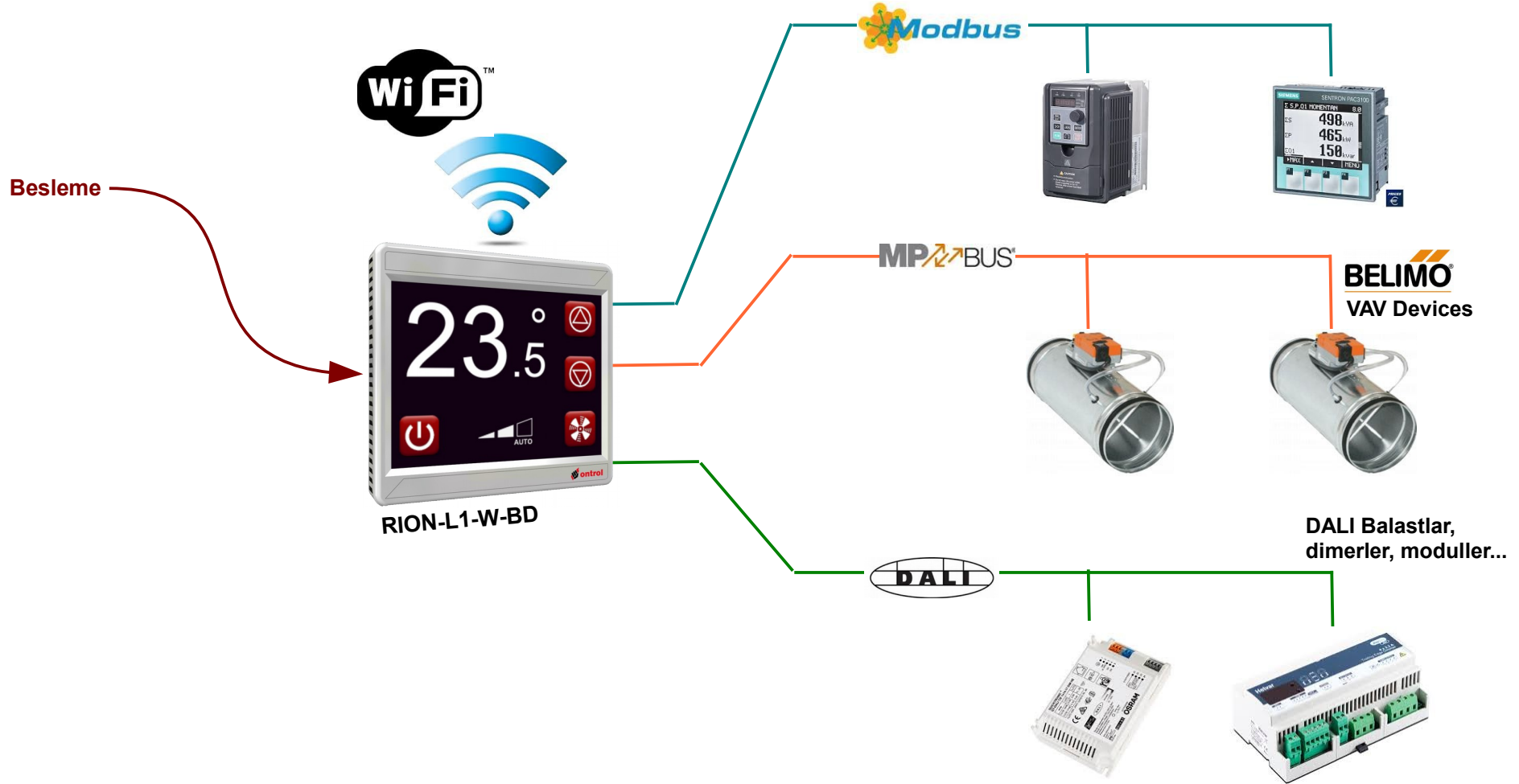

(izleme sistemi için olan RS485 yerine)



- Tüm modellerde RION üzerinde sıcaklık duyar elemanı mevcuttur
- WIFI seçeneği son test aşamasındadır
- WIFI şimdilik sadece Sedona Sox protokolünü destekler

	 SLAVE or MASTER RS485							
	RION-L0-S	RION-L1-S	RION-L0-S-B	RION-L1-S-B	RION-L0-W	RION-L1-W	RION-L0-W-B	RION-L1-W-B
RS485 Modbus RTU Master Sadece	-	✓	-	✓	-	✓	-	✓
Belimo MPBus	-	-	✓	✓	-	-	✓	✓
Özel giriş çıkış modülü ile (R/MIO)	✓	-	✓	-	✓	-	✓	-
Besleme sadece 24Vdc	✓	-	✓	-	✓	-	✓	-
Besleme 24Vac/dc	-	✓	-	✓	-	✓	-	✓

